

JVC



DIGITAL SYSTEM PRINTER

GV-SP2

ENGLISH

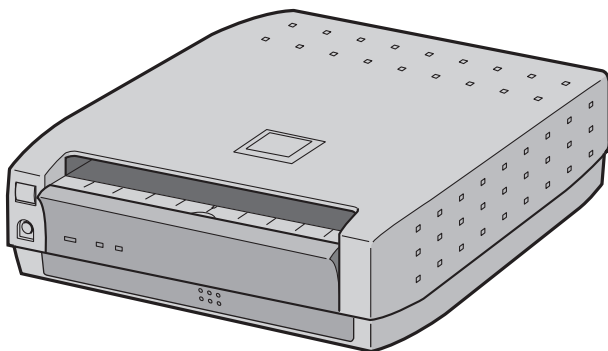

INSTRUCTIONS

LYT0546-001A

EN

Dear Customer,

Thank you for purchasing this Digital System Printer. Before use, please read the safety information and precautions contained in the following pages to ensure safe use of this product.

Using This Instruction Manual

- All major sections and subsections are listed in the Table Of Contents (☞ pg. 4).
- Notes appear after most subsections. Be sure to read these as well.
- Basic and advanced features/operation are separated for easier reference.

It is recommended that you . . .

- ... refer to "Controls, Indicators and Connectors" (☞ pg. 5) and familiarize yourself with button locations, etc. before use.
- ... read thoroughly the Safety Precautions and Safety Instructions that follow. They contain extremely important information regarding the safe use of your new Digital System Printer.

Power Save Mode

1. To put the printer in power save mode, hold down the STANDBY/ON ⏻ button for several seconds while the printer's power is off.
2. During power save mode, printer's power will automatically be turned off if the printer is not used for a while.
3. To print again after the printer's power has been automatically turned off, press the power button once and the power will come back on.
4. To put the printer in power save mode back again, repeat step 1.

You are recommended to carefully read the cautions on page 3 before use.

When the equipment is installed in a cabinet or on a shelf, make sure that it has sufficient space on all sides to allow for ventilation (10 cm or more on both sides, on top and at the rear).

Do not block the ventilation holes. (If the ventilation holes are blocked by a newspaper, or cloth etc. the heat may not be able to get out.)

No naked flame sources, such as lighted candles, should be placed on the apparatus.

When discarding batteries, environmental problems must be considered and the local rules or laws governing the disposal of these batteries must be followed strictly.

The apparatus shall not be exposed to dripping or splashing.



Do not use this equipment in a bathroom or places with water. Also do not place any containers filled with water or liquids (such as cosmetics or medicines, flower vases, potted plants, cups etc.) on top of this unit. (If water or liquid is allowed to enter this equipment, fire or electric shock may be caused.)

SAFETY PRECAUTIONS

WARNING:
TO PREVENT FIRE OR SHOCK HAZARD, DO NOT EXPOSE THIS UNIT TO RAIN OR MOISTURE.

CAUTION

- When you are not using the unit for a long period of time, it is recommended that you disconnect the power cord from the mains outlet.
- Dangerous voltage inside. Refer internal servicing to qualified service personnel. To prevent electric shock or fire hazard, remove the power cord from the mains outlet prior to connecting or disconnecting any signal lead or aerial.

The STANDBY/ON /I button does not completely shut off mains power to the unit, but switches operating current on and off. "  " shows electrical power standby and " I " shows ON.
The mains outlet shall be installed near the unit and shall be easily accessible.

NOTE:

The rating plate (serial number plate) and safety caution are on the bottom and/or the back of the main unit.

IMPORTANT (for U. K. owners)

Connection to the mains supply in the United Kingdom.

DO NOT cut off the mains plug from this equipment. If the plug fitted is not suitable for the power points in your home or the cable is too short to reach a power point, then obtain a proper safety approved extension lead/adaptor or consult your dealer.

BE SURE to replace the fuse only with an identical approved type, as originally fitted, and to replace the fuse cover.

If nonetheless the mains plug is cut off remove the fuse and dispose of the plug immediately, to avoid a possible shock hazard by inadvertent connection to the mains supply.

If this product is not supplied fitted with a mains plug then follow the instructions given below:

DO NOT make any connection to the Larger Terminal coded E or Green.

The wires in the mains lead are coloured in accordance with the following code:

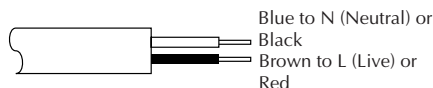

If these colours do not correspond with the terminal identifications of your plug, connect as follows:

Blue wire to terminal coded N (Neutral) or coloured Black.

Brown wire to terminal coded L (Live) or coloured Red.

If in doubt — consult a competent electrician.

Some Do's And Don'ts On The Safe Use Of Equipment

This equipment has been designed and manufactured to meet international safety standards but, like any electrical equipment, care must be taken if you are to obtain the best results and safety is to be assured.

- DO** read the operating instructions before you attempt to use the equipment.
- DO** ensure that all electrical connections (including the mains plug, extension leads and interconnections between pieces of equipment) are properly made and in accordance with the manufacturer's instructions. Switch off and withdraw the mains plug when making or changing connections.
- DO** consult your dealer if you are ever in doubt about the installation, operation or safety of your equipment.
- DO** be careful with glass panels or doors on equipment.
- DON'T** continue to operate the equipment if you are in any doubt about it working normally, or if it is damaged in any way — switch off, withdraw the mains plug and consult your dealer.
- DON'T** remove any fixed cover as this may expose dangerous voltages.
- DON'T** leave equipment switched on when it is unattended unless it is specifically stated that it is designed for unattended operation or has a standby mode. Switch off using the switch on the equipment and make sure that your family knows how to do this. Special arrangements may need to be made for infirm or handicapped people.
- DON'T** use equipment such as personal stereos or radios so that you are distracted from the requirements of road safety. It is illegal to watch television whilst driving.
- DON'T** listen to headphones at high volume, as such use can permanently damage your hearing.
- DON'T** obstruct the ventilation of the equipment, for example with curtains or soft furnishings. Overheating will cause damage and shorten the life of the equipment.
- DON'T** use makeshift stands and NEVER fix legs with wood screws — to ensure complete safety always fit the manufacturer's approved stand or legs with the fixings provided according to the instructions.
- DON'T** allow electrical equipment to be exposed to rain or moisture.

ABOVE ALL...

- **NEVER** let anyone especially children push anything into holes, slots or any other opening in the case — this could result in a fatal electrical shock;
- **NEVER** guess or take chances with electrical equipment of any kind — it is better to be safe than sorry!

If you notice smoke or a peculiar smell coming from the printer, shut it down and unplug it IMMEDIATELY. Use of the printer under these conditions could lead to fire or electric shock. Contact your JVC dealer. DO NOT attempt to repair the malfunction yourself.

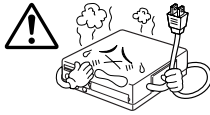

DO NOT attempt to insert foreign objects into the printer, as this can lead to electric shock or fire. If an object other than print paper is accidentally inserted, shut the printer down, unplug it and contact your JVC dealer.

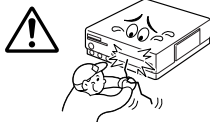

Exercise caution when moving the printer. If you drop the unit, do not attempt to use it. If during use you notice that the cabinet is damaged, shut the printer down, unplug it and contact your JVC dealer. Use of the printer under these conditions can lead to fire or electric shock.

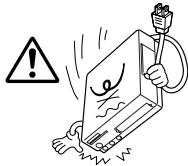

DO NOT place heavy objects on the printer's power cord, or leave the cord near any heat-generating appliance, as this can damage the cord. Avoid excessive pulling or twisting of the power cord. If the power cord becomes cut or otherwise damaged, contact your JVC dealer. When unplugging the printer, DO NOT pull on the cord. Hold the plug itself and remove it from the AC outlet. Use of the printer with a damaged power cord can lead to fire, electric shock and unit malfunctions.



DO NOT remove the cover and attempt to repair or modify the printer. There are high-voltage components within the unit, and the risk of electric shock and unit malfunctions exists. If a problem occurs, contact your JVC dealer.



Make sure that you have easy access to the AC outlet which the printer is plugged into so that it can be immediately unplugged in case of emergency. Connect the printer power plug to a different AC outlet from the TV and VCR.

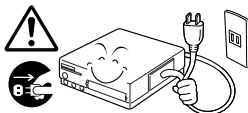

ABOUT THERMAL HEADS

- The thermal heads, necessary for printing, are located within the unit. The heads can become extremely warm. To prevent possible burns and injuries, do not touch the thermal heads.
- When the printer is used for extended periods, the thermal heads experience wear and tear just like VCR heads. As the thermal heads become worn, print quality will gradually decrease. When you notice a decline in quality, it is possible that the heads may need to be replaced. Consult your JVC dealer.

MOISTURE CONDENSATION

If condensation occurs inside the printer, it may adhere to print paper during printing, causing poor quality prints and paper jams. If you think condensation may exist within the unit, let the unit sit for at least 2 hours (with the power on) to dry sufficiently. If paper is stuck within the unit, remove it before turning the power on. Unused print paper subjected to moisture should not be used for printing.

- Condensation may occur in the following situations:
 - 1) In a room when the heater suddenly comes on;
 - 2) In the direct path of cool air from an air conditioner;
 - 3) When the unit is moved from a cool place to a warm place.

DUST

Due to dust or lint adhering to print paper, or to extreme variations in temperature, a small degree of colour smearing or lines may be visible in prints.

Failure to heed the following precautions may result in damage to the printer.

1. **DO NOT** place the printer . . .
 - ... in an environment prone to extreme temperatures or humidity.
 - ... in direct sunlight.
 - ... in a dusty environment.
 - ... in an environment where strong magnetic fields are generated.
 - ... on a surface that is unstable or subject to vibration.
2. **DO NOT** block the printer's ventilation openings.
3. **DO NOT** place heavy objects on the printer.
4. **DO NOT** place anything which might spill on top of the printer.
5. **AVOID** violent shocks to the printer during transport.

CAUTION:

Changes or modifications not approved by JVC could void user's authority to operate the equipment.

CONTROLS, INDICATORS AND CONNECTORS	5
PREPARATION	6
INSTALLATION OF INK CASSETTE	8
LOADING THE PAPER TRAY	9
CABLE CONNECTION	10
USING THE STAND	11
CLEARING PAPER JAM	12
PC PRINTER EDITION for Windows®	13
INSTALLING THE SOFTWARE	14
PRINTING UNDER Windows®	16
PRINTER DRIVER SETTINGS	18
IF YOU CANNOT PRINT	20
PC PRINTER EDITION for Macintosh®	21
PC PRINTER EDITION FOR Macintosh®	22
INSTALLING THE SOFTWARE	23
PRINTING UNDER Macintosh®	24
SETTINGS ON THE PAPER SETTING DIALOG BOX	26
SETTINGS ON THE PRINT DIALOG BOX	27
ERROR MESSAGES	28
SPECIFICATIONS	30

PROVIDED ACCESSORIES

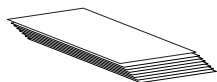

Color Print Paper Sheet Set

- Standard Print Paper (10 sheets)
- Ink Cassette (10 prints)

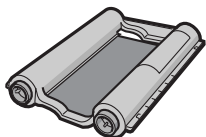

Printer Cable

Length: Approx. 1.0 m
For connecting the video equipment to the printer

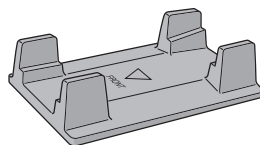

Stand

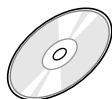

CD-ROM

- Printer Driver (Windows® and Macintosh®)



Ferrite core (1 pc.)
For USB cable

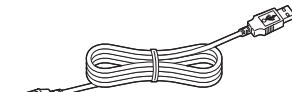

USB cable (commercially available)
For connecting the PC and printer (A-B connector type)

- It should be noted that it may be unlawful to print from pre-recorded tapes or discs without the consent of the owner of copyright in the video recording, broadcast or cable program and in any literary, dramatic, musical, or artistic work embodied therein.

Front View

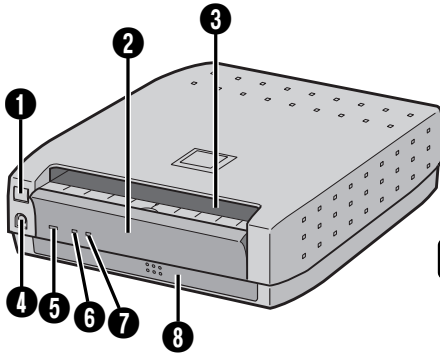

Rear View

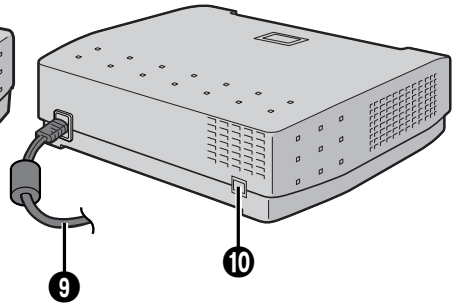

1 STANDBY/ON ϕ /I button

- Turns the printer on and off.

2 Ink Cassette Access Door

- Open this to load or unload the ink cassette.

3 Paper outlet

- Prints are output from here.

4 PRINT DATA input connector

- Connect to the video camera's printer output connector using the provided printer cable.

5 STANDBY/ON ϕ /I lamp

- Lights when the printer is turned on.

6 PRINT lamp

- Flashes when receiving image data.
Lights during printing.

7 ERROR lamp

- Indicates that an error has occurred in the printer.
If this lamp lights or begins flashing, check the message that is displayed on the video camera.

8 Paper tray

- Insert papers here.

9 Power cable

- Plugs into household electrical outlet.
Always press the STANDBY/ON ϕ /I button and turn off power before unplugging the power plug from the electrical outlet.

10 USB terminal

- Connects to the USB terminal on the PC via a commercially available USB cable.
- USB Interface Support**
This printer supports USB (Universal Serial Bus), the new standard serial interface.

- Before printing, make sure everything is set up and ready.

1 Have a Color Print Paper Sheet Set ready (page 7).



2 Install the ink cassette in the printer (page 8).



3 Place the color print paper sheets in the paper tray and load the tray (page 9).

- Use the print sheets and ink cassette from the same kit.



4 Connect an image source to the printer (page 10).



5 Plug the printer's power cable into an AC outlet and press the STANDBY/ON  button.

- Power comes on and the STANDBY/ON  lamp lights.



This completes preparations. Before printing, thoroughly read the instruction manual for the connected video equipment and pages 13 through 27 of this manual for details on USB printing.

About Color Print Paper Sheet Sets (optional)

You must use one of the sets shown in the following chart:

SET	CONTENTS	USES
PX-K50SFAU (Standard type)	<ul style="list-style-type: none"> • Standard Print Paper (50 Sheets) • Ink Cassette (50 Prints) 	Print your favorite images, just like snapshots.
PX-K25UFAU (Glossy type)	<ul style="list-style-type: none"> • Super-Fine High Grade Paper (25 Sheets) • Ink Cassette (25 Prints) 	Make customized picture postcards, greeting cards, etc. with less color fading compared to standard paper.

Before Printing

- Do not touch the printing side of the paper.
- Insert the printing paper shiny side up (the side with no printing on it) in the paper tray. A paper jam could result if the paper is inserted with the wrong side facing up.
- Do not use folded, creased, curly, or perforated paper in the printer. Doing so could result in a paper jam or other malfunction.
- Do not use paper that is wet or damp. Printing may not be possible and paper jamming may occur.
- Do not touch or pull out the ink cassette's ink sheet.
- Keep young children away from the ink cassette's ink sheet.
- When the ink cassette is empty, replace it with a new one. A spent ink cassette cannot be reused. Do not try to rewind and re-use cassette.
- Do not expose the paper to high temperatures, high humidity and/or direct sunlight.
- You can write on the back side of a print sheet.
- If you want to write something or stick a stamp on a sheet, wait until printing is finished. If you write something or stick something on before printing, the printer may not work properly.
- Carefully read the precautions in the color print paper sheet set box and on the back of the color print paper sheet set before using.

After Printing

- If you touch a fresh print with wet hands, the print image may be discolored.
- If a print absorbs organic cleaning solvents (alcohol, ester, keton, etc.), the colors will fade.
- If cellophane tape or soft PVC are affixed to a print, the chemical reaction will cause accelerated color fading.
- When writing on a print sheet, be sure to use a pencil or an oil-based writing utensil. If you apply too much pressure, you'll leave imprints on the print sheet.

Storage

- Avoid storing prints in areas subject to high temperatures or humidity, or near a heater or heat-generating device.
- Do not store prints in a soft plastic folder. Accelerated color fading may result due to the chemical reaction, or the print(s) may stick to the folder.
- Do not store 2 prints with the printed sides touching, as the sheets may stick together.
- Store print paper in its box, on a level surface. Failure to do so may cause the print paper to curl or bend, which can result in a paper jam within the unit.

Install the ink cassette included with the optionally available color print paper sheet set.

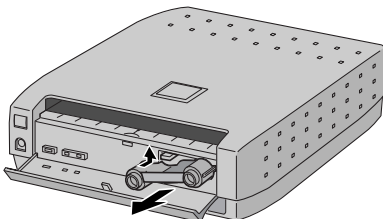
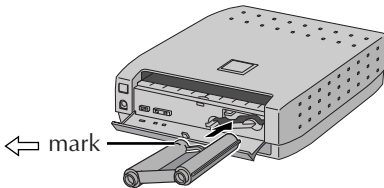
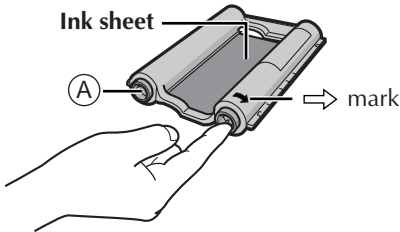
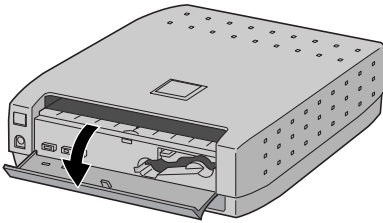

1 OPEN CASSETTE DOOR

Pull the door in the direction indicated by the arrow to open it.

2 TAKE UP SLACK

Remove the shipping material which locks the rollers.

Turn the roller on the side with the ⇔ mark in the direction of the arrow.

Do not turn the part marked with (A).

3 INSTALL INK CASSETTE

Insert the ink cassette with the ⇐ mark toward the left, on the end going into the printer. The ⇐ mark points toward the power lamp. Push it until you hear a click.

4 CLOSE CASSETTE DOOR

The door clicks when it is fully closed.

When removing ink cassette

Push up the lock lever.

The ink cassette is unlocked and can be removed.

CAUTION

Do not stick your fingers into the ink cassette storage space. You may be burned or injured.

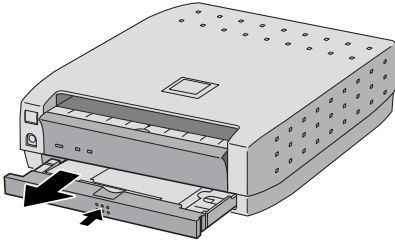

Removing and Attaching the Paper Tray

- Push the tray slightly to unlock the latch, then pull it out.
- To attach, insert until you hear the paper tray catch in place.

Loading paper in the paper tray

1. Adjust partition panel **(A)** according to the paper size.
2. Press down the lever and insert the paper.
 - Load the paper shiny side up, with the side that has the wider area beyond the perforations closest to partition panel **(B)**. Load no more than 25 sheets.
3. Adjust partition panel **(B)** according to the paper size. After inserting the paper, push in **(C)** until it clicks into place.

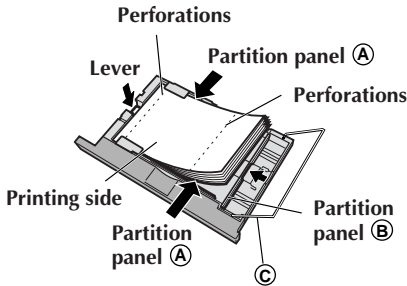

NOTES:

- Fan the paper to separate the individual sheets.
- Be sure to thoroughly read the precautions listed on the paper tray.
- Place the printing paper shiny side up (the side with no printing on it) in the paper tray. A paper jam could result if the paper is inserted with the wrong side facing up.
- If a paper jam occurs, refer to page 12, "Clearing a Paper Jam."
- Remove the paper from the paper outlet. If more than 25 sheets accumulate in the paper outlet, a paper jam could result.

Connect the printer to an AC outlet. Use a different AC outlet from the one used for the TV and VCR.

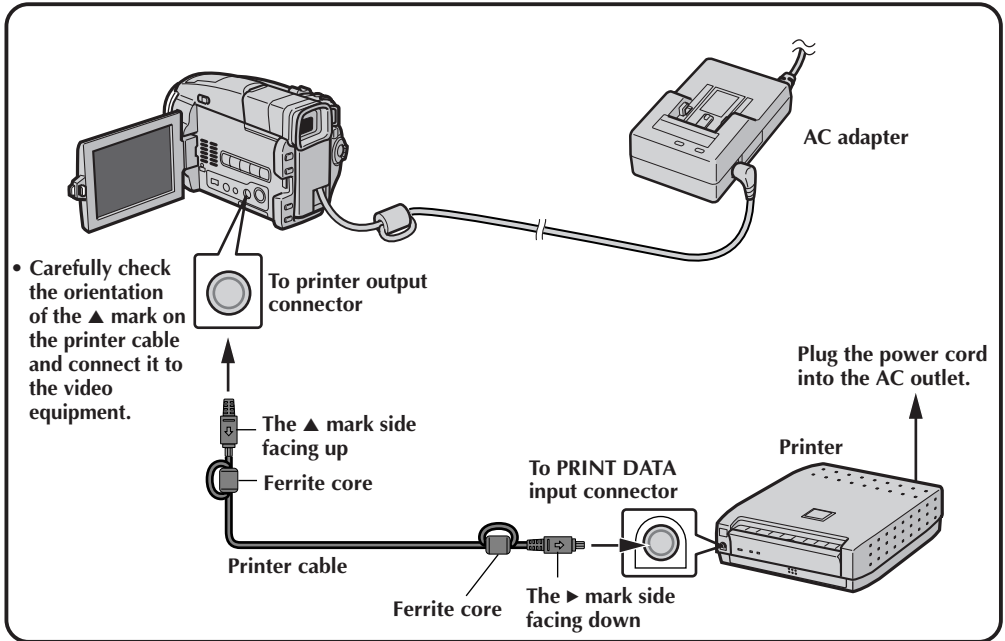

Read the instruction manual for the equipment to connect.

The equipment you are using has a dedicated printer output connector. Refer to the instruction manual for the equipment when connecting it to the printer.

Use the stand when cramped for space

If there is not enough space to lay the printer flat, you may attach the printer vertically to the supplied stand.

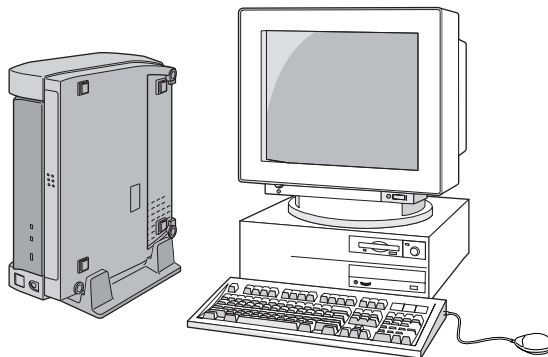
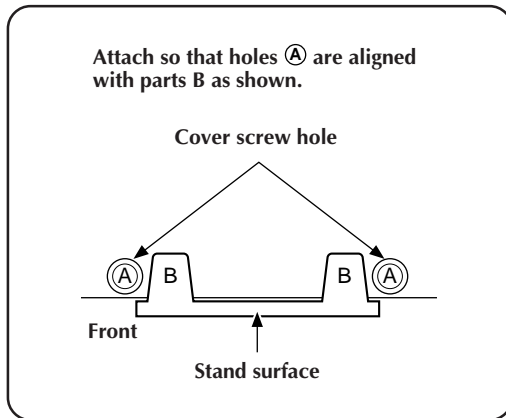
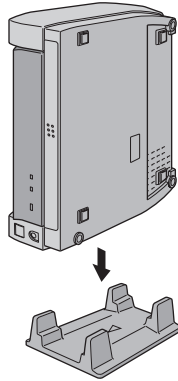

Clearing a Paper Jam

If a paper jam occurs, turn the printer off, and then turn it back on again. When the power is turned on, the printer checks the position of the paper and automatically performs a reset operation, ejecting any paper inside the printer.

If turning on the printer again does not eject the jammed paper, turn the printer off again.

If repeating this operation several times still does not clear the jammed paper, it will be necessary either to remove the paper yourself or else to contact your JVC dealer.

If you can see the jammed paper:

- If you can see the jammed paper in the paper outlet on the top of the printer, turn off the printer, unplug the power cord, and then use a narrow grasping tool, such as a pair of tweezers, to grasp the paper and pull it out. Be careful not to tear the paper. In some cases the ink sheet will be adhering to the paper; pull both out carefully.
- If the ink sheet is stuck on the paper, slowly peel the ink sheet from the paper, and then slowly remove the ink cassette from the printer.
- If the ink sheet is not damaged, you can continue to use the ink cassette after taking up the slack in the ink sheet. However, it is possible that the next print made with this ink cassette may not come out well.
- If the ink sheet is damaged, the ink cassette can not be used anymore.
- If you can see the jammed paper in the paper tray inlet, etc., but are not able to remove it, do not continue attempting to remove the paper. Instead, contact your JVC dealer.

If you can not see the jammed paper:

- If you do not know where the paper is jammed or if the paper tray is stuck, do not attempt to remove the paper. Instead, contact your JVC dealer.

PC PRINTER EDITION for Windows®

- Additional information regarding setup and information not contained in the instruction manual can be found in the file readme.txt. Please read this file before installing the accompanying software.
- For the latest information regarding this software, please visit our website at <http://www.jvc-victor.co.jp/>.

Operating Environment

The host computer running the Windows® operating environment must satisfy the following four conditions.

1. Be a PC with Windows® 98 installed
2. Be a USB-compatible computer
3. Be warranted for USB operations by the computer manufacturer
4. Have 32 MB or more of RAM, 256-color or better video, and have an MMX 150-MHz or better CPU

NOTE:

There are variations of the USB interface in various brands of personal computers. Therefore JVC cannot guarantee that your computer will be compatible with this printer.

* Windows® 98 is a registered trademark of Microsoft Corporation in the US and other countries.

Connecting the USB Cable

Attach the supplied ferrite core to the USB cable. (See page 22.)

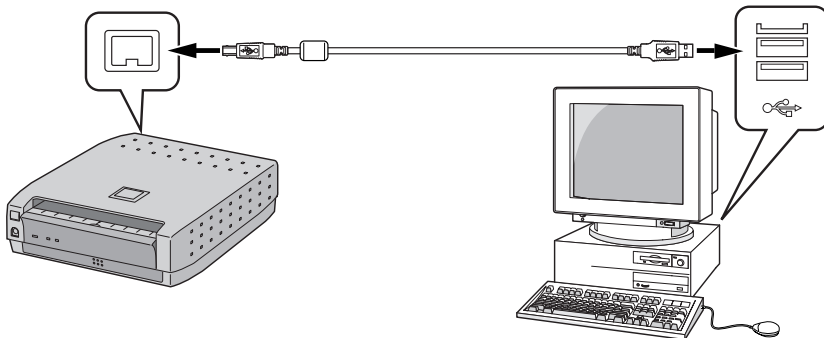

NOTE:

Check that the terminal of the USB cable matches that of the connected video equipment and connect.

Installing the USB Driver

1 TURN ON THE POWER OF THE GV-SP2**2** CONNECT THE GV-SP2 TO THE PC USING THE USB CABLE

- Display the "Add New Hardware Wizard" window.

3 LOAD THE CD-ROM**4** CLICK THE **Next** BUTTON**5** CLICK THE **Next** BUTTON**6** CONFIRM THAT "CD-ROM drive" HAS BEEN CHECKED AND CLICK THE **Next** BUTTON



7 CLICK THE **Next** **BUTTON**



8 CLICK THE **Finish** **BUTTON**



9 CLICK THE **Next** **BUTTON** ON THE **"Welcome"** **WINDOW**



10 CLICK THE **Finish** **BUTTON** ON THE **"Setup Complete"** **WINDOW**

Installing the Printer Driver

Steps Required to Print

Turn on the printer's power and connect the USB cable.

- Check that the ink cassette is installed in the printer. (See page 8.)
- You can tell the print status using the lamps on the printer.



Load the print paper.

- Load the print paper in the paper tray and attach to the printer. (See page 9.)



Create the data to be printed.

- Create the data to be printed using application software.



Make printer settings using the printer driver.

- Various printer settings can be made.



Print the job.

- The PRINT lamp will flash and the job will begin printing.

Printing an Image

Add text and process using commercially available software, and then print.

1 TURN ON THE PRINTER'S POWER AND CONNECT THE USB CABLE

- Make sure the ink cassette and print paper are ready.

2 OPEN THE IMAGE FILE TO BE PRINTED

- Select **File – Open** and click on the name of the image file you want to print.

3 MAKE PRINTER SETTINGS

- Selecting **File – Print** will cause the **Print** window to appear. Select **JVC GV-SP2** under the printer name item.
- Various printer settings can be changed on the printer's setup window. (See page 18.)

4 PRINT THE IMAGE

- Click the **OK** button on the **Print** window.

Printer driver settings are divided into several menus (dialog boxes). This section gives a brief description of these menus and the items found on them.

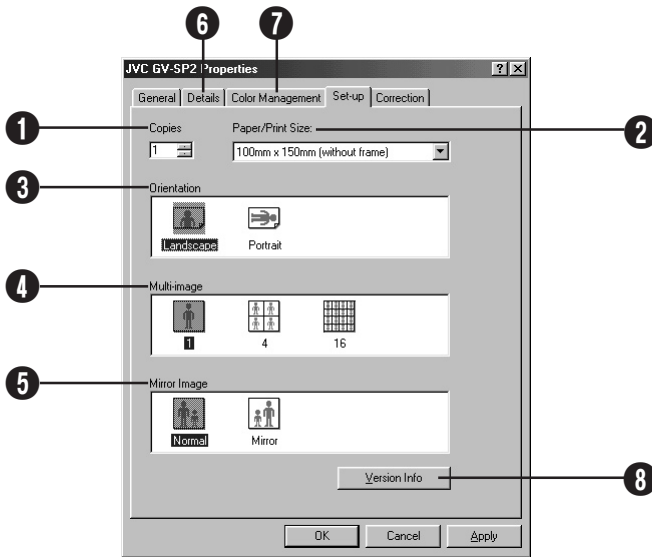

1 Copies

Set when consecutively printing the same screen. A setting from 1 to 25 can be made.

2 Paper/Print Size

Displays the paper size to be printed on.

3 Orientation

Selects the page orientation.
Landscape/Portrait

4 Multi-image

Select how many times you want the same scene to appear on a single page.
• 1 image, 4 images, or 16 images

5 Mirror Image

Select when you want to print with left and right reversed in the image being printed.

6 Details

This tab is used to select the port to which data is to be printed and the driver to be used. It is also used to make pool settings.

7 Color Management

These settings let you associate color profile(s) with your color printer.

- Automatic
- Manual

8 Version Info

Displays the version of the GV-SP2 printer driver.

- Click the **OK** button after confirmation.

Although it is normally possible to obtain print results of sufficient quality just by setting the print type and paper size, this section describes how to use the menus to increase print quality even further.

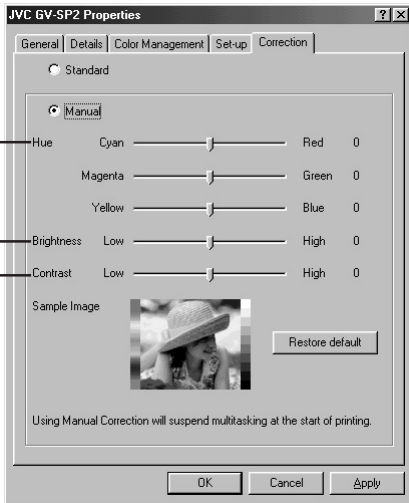

1. Image quality adjustment (Hue)

Select when you want to change the hue by adjusting the shade of cyan, magenta and/or yellow.

1 Cyan adjustment

A blue-green results when the setting is increased in the cyan direction while cyan's complementary color, red, is intensified when the setting is increased in the red direction.

2 Magenta adjustment

A reddish-purple results when the setting is increased in the magenta direction while magenta's complementary color, green, is intensified when the setting is increased in the green direction.

3 Yellow adjustment

Yellow is intensified when the setting is increased in the yellow direction while yellow's complementary color, blue, is intensified when the setting is increased in the blue direction.

- The intensities of each of these colors can be adjusted using a bar.

With "0" as the default, these values can be adjusted between -100 to +100.

2. Brightness adjustment

Make this adjustment when the color appears darker or lighter in the printout than it does displayed on the screen.

- Adjust the brightness of the entire image using the bar.

With "0" as the default, this value can be adjusted between -100 to +100.

Negative values result in a darker image while positive ones result in a brighter image. This setting is effective when dealing with images that are too dark or too bright overall.

3. Contrast adjustment

Make this adjustment when differences in brightness for the entire image are not clearly defined or when the image appears fuzzier in the printout than it does displayed on the screen.

- Adjust the contrast of the entire image using the bar.

With "0" as the default, this value can be adjusted between -100 to +100.

Increasing the contrast makes the bright areas appear brighter and the dark areas appear darker, while decreasing the contrast decreases the apparent difference in brightness between bright and dark areas.

NOTE:

When you adjust the print quality using the Manual Correction settings the computer needs extra processing time. Therefore, when you print after adjusting the print quality you may experience a period of up to 90 seconds, when your computer becomes unresponsive. This is normal. After this time the status window appears and operation is restored.

Check the following if you cannot print.

Preparations: Select *My Computer – Printers*, right click on *JVC GV-SP2*, and select *Properties*.

1 SET *Properties – Details – Print to the following port: TO SP2PORT: (JVC GV-SP2 PDD Port)*

2 SET *Print using the following driver: TO JVC GV-SP2*

3 CLICKING ON *Spool Settings...* WILL DISPLAY THE PRINTER'S SPOOL SETTINGS
SELECT *Enable bi-directional support for this printer*

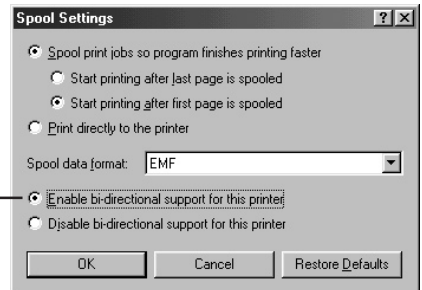
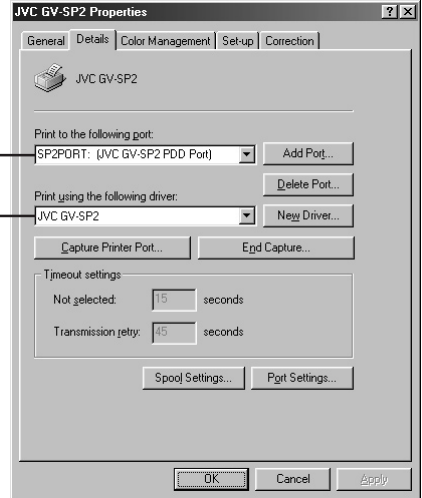

PC PRINTER EDITION for Macintosh®

- Additional information regarding setup and information not contained in the instruction manual can be found in the file *about GV-SP2* on the harddisk. Please read this file before installing the accompanying software.
- For the latest information regarding this software, please visit our website at <http://www.jvc-victor.co.jp/>.

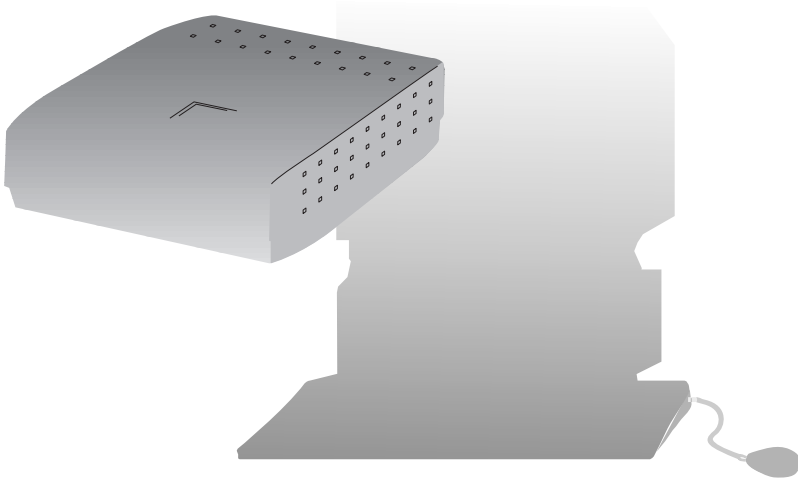

Operating Environment

The host computer running the Macintosh® operating environment must satisfy the following two conditions.

1. Be a computer with Mac OS 8.6 / Mac OS 9.0 installed
(A minimum of 64MB of RAM is recommended.)
2. Be a USB-compatible computer with built-in USB port
(iMac™, iBook™ and Power Mac™ G3/G4, PowerBook™ G3)

NOTE:

There are variations of the USB interface in various brands of personal computers. Therefore JVC cannot guarantee that your computer will be compatible with this printer.

* Macintosh® is a registered trademark of Apple Computer.

Connecting the USB Cable

Attach the supplied ferrite core to the USB cable. (See below.)

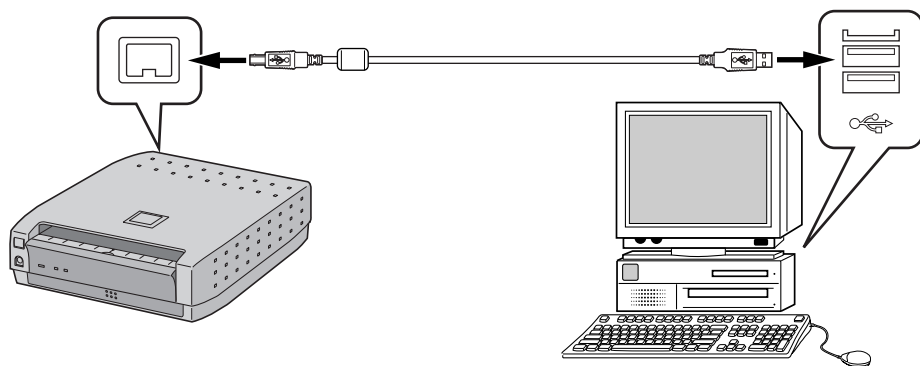

NOTE:

Check that the terminal of the USB cable matches that of the connected video hardware and connect.

The Ferrite Core

When using an optional USB cable, be sure to attach the ferrite core to the cable. Use of the ferrite core reduces the noise that occurs when connecting the PC.

1



Stoppers

2

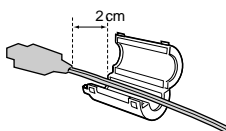

3

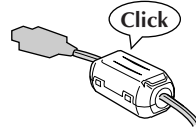

1 Pop the stoppers at both ends and open.

2 Put the ferrite core around the cable.

- Attach the ferrite core at a location about 2 cm from the terminal.

3 Clamp around the cable and close until you hear the stoppers catch in place.

- When connecting the cable, be sure to connect the terminal at the end where the ferrite core is attached to the system printer.

Installing the Software

For details on the basic operation of the Macintosh, please refer to the instruction manual supplied with the computer.

Preparations: Start the Macintosh.

- Exit from any other software currently being used.
Turn on the printer's STANDBY/ON ⏻ button.

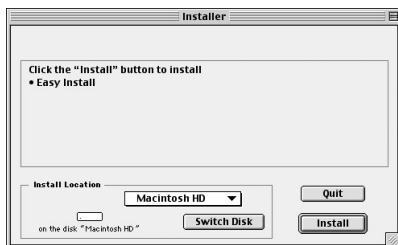
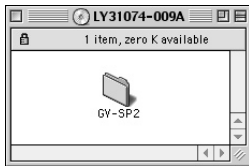

1 CONNECT THE GV-SP2 TO THE PC USING THE USB CABLE

2 TURN ON THE POWER OF THE GV-SP2

3 INSERT THE SUPPLIED CD-ROM INTO THE CD-ROM DRIVE

4 DOUBLE CLICK ON THE ICON FOR THE LOADED CD-ROM

5 DOUBLE CLICK ON THE GV-SP2 FOLDER AND DOUBLE CLICK ON THE *Installer* ICON

6 CLICK *Install* IN THE *Installer* DIALOG BOX

7 CLICK *Restart* TO RESTART THE Macintosh

- Installation is complete when the GV-SP2 Printer is displayed on the **Chooser** window on the **Apple** menu.

Steps Required to Print

Turn on the printer's power and connect the USB cable.

- Check that the ink cassette is installed in the printer. (See page 8.)
- You can tell the print status using the lamps on the printer.



Select the GV-SP2 using the selector.



Make paper settings and create the data to be printed.

- Make paper settings and create the data to be printed using application software.



Make printer settings using the printer driver.

- Various printer settings can be made.



Print the job.

- The PRINT lamp will flash and the job will begin printing.

Printing an Image

Add text and process using commercially available software, and then print.

1 TURN ON THE PRINTER'S POWER AND CONNECT THE USB CABLE

- Make sure the ink cassette and print paper are ready.

2 OPEN THE IMAGE FILE TO BE PRINTED

- Select **File – Open** and click on the name of the image file you want to print.

3 MAKE PRINTER SETTINGS

- Selecting **File – Page Setup** will cause the page setup window to appear. Make settings for items such as the paper size, etc. (See page 26.)
- Selecting **File – Print** will cause the print window to appear. This window is for setting information such as the number of print copies and other options, and can be used to adjust the image quality. (See page 27.)

4 PRINT THE IMAGE

- Click the **Print** button on the print window.

26_{EN} SETTINGS ON THE PAPER SETTING DIALOG BOX

Settings on the paper setting dialog box are divided into several categories. This section gives a brief description of the available setting items.

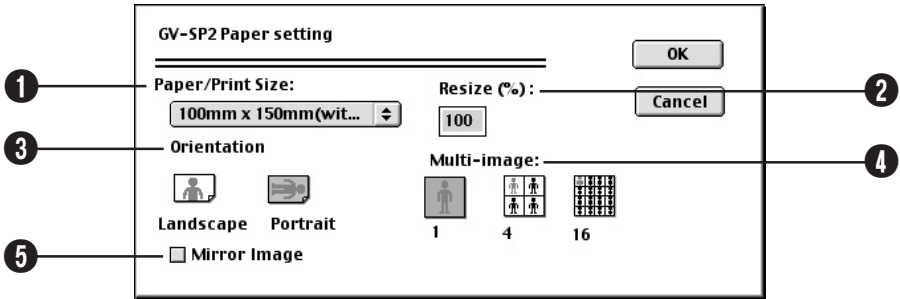

1 Paper/Print Size

Displays the paper size to be printed on.

2 Resize

A reduction ratio to be used during printing can be set. Note, however, that the settable range for the reduction ratio may differ depending on the paper size and application software being used.

3 Orientation

Selects the page orientation.
Landscape/Portrait

4 Multi-image

Select how many times you want the same scene to appear on a single page.

- 1 image, 4 images, or 16 images

5 Mirror Image

Select when you want to print with left and right reversed in the image being printed.

Although it is normally possible to obtain print results of sufficient quality just by setting the print type and paper size, this section describes how to use the menus to increase print quality even further.

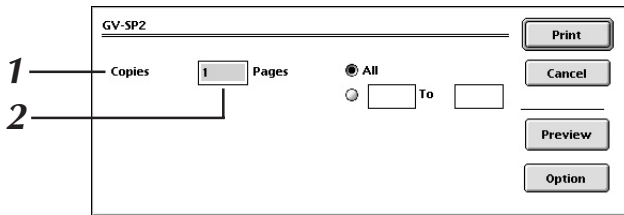

Option Screen

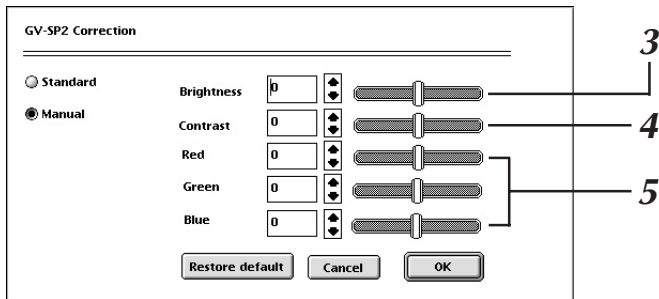

1. Number of print copies

Set when consecutively printing the same screen. A setting from 1 to 25 can be made.

2. Print pages

Specifies the page to be printed. Selecting **All** will print all pages of the image. Pages can be selected when specifying the pages to be printed.

3. Brightness adjustment

Make this adjustment when the color appears darker or lighter in the printout than it does displayed on the screen.

- Adjust the brightness of the entire image using the bar. With "0" as the default, this value can be adjusted between -100 to +100. Negative values result in a darker image while positive ones result in a brighter image. This setting is effective when dealing with images that are too dark or too bright overall.

4. Contrast adjustment

Make this adjustment when differences in brightness for the entire image are not clearly defined or when the image appears fuzzier in the printout than it does displayed on the screen.

- Adjust the contrast of the entire image using the bar. With "0" as the default, this value can be adjusted between -100 to +100. Increasing the contrast makes the bright areas appear brighter and the dark areas appear darker, while decreasing the contrast decreases the apparent difference in brightness between bright and dark areas.

5. Image quality adjustment (hue)

Select when you want to change the hue by adjusting the shade of Red, Green and/or Blue.

- The intensities of each of these colors can be adjusted using a bar. With "0" as the default, these values can be adjusted between -100 to +100.

NOTE:

When you adjust the print quality using the Manual Correction settings the computer needs extra processing time. Therefore, when you print after adjusting the print quality you may experience a period of up to 90 seconds, when your computer becomes unresponsive. This is normal. After this time the status window appears and operation is restored.

WHAT TO DO IF ANY OF THE MESSAGES BELOW APPEAR ON THE PC

Message	<ul style="list-style-type: none"> ● Appears when: ■ Action: 	Page
The specified number is more than the maximum number of print pages.	<ul style="list-style-type: none"> ■ Set a value that does not exceed the maximum number of sheets that can be printed. 	18, 27
The specified number is less than the minimum number of print pages.	<ul style="list-style-type: none"> ■ Enter a value other than "0." 	18, 27
Set ink cassette.	<ul style="list-style-type: none"> ● This message appears if no ink cassette has been installed, or if it has not been installed properly. ■ Insert an ink cassette and close the door. 	8
Pull out paper tray and check paper.	<ul style="list-style-type: none"> ● This message appears if the printer is out of paper. ■ Load more paper. 	9
Insert paper tray.	<ul style="list-style-type: none"> ● This message appears if the paper tray has not been inserted. ■ Insert the paper tray. 	9
Replace Ink Cassette.	<ul style="list-style-type: none"> ● This message appears if the ink cassette has been used up. ■ Replace the old cassette with a new one. ● This message appears when the paper size set on the PC does not match the type of ink cassette being used. ■ Check that the paper size set on the PC matches the ink cassette. 	8, 18, 26
Check ink cassette.	<ul style="list-style-type: none"> ● This message appears when a damaged ink cassette is inserted. ■ Replace with a new ink cassette. 	8
Paper type is not compatible. Pull out paper tray and check paper. (for Windows)	<ul style="list-style-type: none"> ● This message appears if the paper size set on the PC does not match the printing paper. ■ Check that the paper size set on the PC matches the printing paper. 	9, 18
Paper type is not compatible. Printing aborted. (for Macintosh)	<ul style="list-style-type: none"> ● This message appears if the paper size set on the PC does not match the printing paper. ■ Check that the paper size set on the PC matches the printing paper. 	9, 26
Print error has occurred. Printing aborted.	<ul style="list-style-type: none"> ● This message appears if the printing operation could not be performed normally. This message is displayed when there is a paper jam, when paper orientation is incorrect, or when the paper is upside down. ■ Remove the paper that was ejected. ■ Turn the power off, unplug the power cord, plug the power cord back in, and then turn the power on again. If after doing so this message still appears, contact your dealer or a JVC Service Center. 	—
Printer is overheated. Please wait.	<ul style="list-style-type: none"> ● This message appears while the printer is cooling off if the printer's internal temperature has risen too high. 	—
Printer is not in usable condition. Printing aborted.	<ul style="list-style-type: none"> ● This message appears if the printer is being used by another device. ■ Print to the GV-SP2 after the other device has finished printing. 	17, 25

Message	<ul style="list-style-type: none"> ● Appears when: ■ Action: 	Page
Printer is not connected or Power OFF. Printing aborted.	<ul style="list-style-type: none"> ● This message appears if the printer power is not on, or if the power supply is not connected properly. ■ After connecting the power supply properly, turn on the printer. 	13, 22
Printing data was not transmitted. Printing aborted.	<ul style="list-style-type: none"> ● This message appears if an attempt was made to print without first sending the printing data to the printer. ■ Load the image into the personal computer first, and then initiate the printing operation. 	17, 25
Data transmission error has occurred. Printing aborted.	<ul style="list-style-type: none"> ● This message is displayed when communication has become impossible due to a faulty USB cable connection or for some other reason while sending an image to the printer. ■ Check the USB cable connection and try printing again. 	13, 22
Do you want to abort printing?	<ul style="list-style-type: none"> ■ To stop printing while printing is in progress, click Stop. 	—
Memory is not enough. Printing aborted.	<ul style="list-style-type: none"> ● This message is displayed when the memory capacity of the PC is insufficient. ■ Add more memory or close any other applications that may be running currently. 	—
Data deleted from spooler. Printing stops.	<ul style="list-style-type: none"> ● This message is displayed because print data has been deleted from the spooler. ■ Repeat the print procedure to re-print. 	13, 22
Bi-directional communications are not supported. Please enable bi-directional communications on the Printer Properties window.	<ul style="list-style-type: none"> ■ Click Properties – Details, and then Spool Settings... to display the Spool Settings window. Select Enable bi-directional support for this printer. 	20
The spool settings are incorrect. The settings are automatically changed. Press the OK button and try printing again.	<ul style="list-style-type: none"> ● The Spool Settings... under Properties – Details have not been made correctly. ■ Take the action indicated in the on-screen message. 	20
Invalid data. Select an appropriate printer driver.	<ul style="list-style-type: none"> ● This message is displayed when an attempt is made to utilize the USB driver for this device with a printer driver other than that for this device. ■ Check the model of the printer being used and check the printer specified in the field Print to the following port: on the printer's Properties window. 	20
Software requirements are damaged. Install the printer driver again.	<ul style="list-style-type: none"> ● The printer driver has not been installed properly. ■ Re-install the printer driver. 	14, 23

Power	AC 220 – 240 V ~, 50 Hz
Power consumption	During printing : Approx. 74 W
Print format	Sublimation dye thermal transfer line printing
Print quality (Resolution)	BORDER (OFF) : 1220 (horiz.) x 1828 (vert.) dots BORDER (ON) : 1152 (horiz.) x 1536 (vert.) dots
Resolution	310 dpi
Print medium	Ink sheet : Cartridge (dedicated) 3-color consecutive printing (yellow, magenta, cyan) Print sheet : Paper size 100 mm x 171 mm (dedicated) Maximum print area 100 mm x 150 mm (BORDER: OFF) 94.4 mm x 125.9 mm (BORDER: ON)
Print speed * Transmission and processing of video data is not included.	Standard Paper: 80 sec. Super-Fine High Grade paper: 105 sec.
Connectors	PRINT DATA Input connector USB connector
Operating temperature	+5°C — +35°C
Operating humidity	35% — 80%
Storage temperature	-20°C — +60°C
Operating position	Level (horizontal) ±5°
Dimensions	262 W x 79 H x 253.5 D mm
Weight	Approx. 2.2 kg (including paper tray)

Design and specifications subject to change without notice.

EN

GV-SP2

JVC
VICTOR COMPANY OF JAPAN, LIMITED